



OPTOCORE



Operating Manual for OPTOCORE DD6NE

FAST ETHERNET DISTRIBUTION SWITCH MODULE
Optical Digital Network Device

© Copyright 2007 All rights reserved

OPTOCORE GmbH
Lohenstr. 8
82166 Munich-Gräfelfing
Germany

Important Safety Instructions

- Please read this manual carefully.
- Please keep this operating manual in a safe place.
- Heed all warnings.
- Follow all instructions.
- This device may only be used in accordance to the information provided in this operating manual. Ensure that all recommendations, especially the safety recommendations as detailed in this operating manual, are followed before and during the usage of the device.
- Do not use this device near water, for example, in moist or damp rooms.
- Clean only with a dry cloth.
- Do not block or cover any ventilation slits. Install the device in accordance to the operating manual.
- Do not install or place the device near any heat source such as radiators, power-amplifiers, stoves, or any other heat producing equipment.
- Protect the power cord from being walked on, crushed, pinched, or damaged in any other way. Pay special attention to plugs and sockets of the device.
- Never switch on power amplifiers before the complete system is stable and the level meters of the OPTOCORE CONTROL software indicate a normal level.
- Do not place this device on an unstable table, tripod, cart, etc. The device may fall, causing serious damage to the device.
- The device can only be removed from the power supply by pulling the plug. This must be freely accessible at all times. The device has to be disconnected during lightning storms or when unused for long periods of time.
- The device must be grounded; any disconnection of the grounding is not permitted.
- The switched-mode power supplies operate with high voltage. Coming into contact with them can lead to considerable electric shocks, which may result in death.
- Only use attachments specified by the manufacturer.
- This device contains no user serviceable parts: only refer to authorized, qualified service personnel for any servicing.
- Your warranty will be voided if you tamper with the internal components.

Purchaser Information

- **Operating Manual**

Please read this manual – if you call for technical support, we'll assume that you have. Study the operating manual carefully in order to familiarize yourself with the device and its operation. It contains numerous information and hints for the proper use of the device.

It cannot be excluded that this operation manual shows typographical mistakes or misprints; it is however regularly revised.

Modifications, which serve the purpose of technical improvement of the device, may be carried out without prior notification.

- **Transport and Shipping**

Always ensure the careful handling of the device. If possible transport or shipping should always occur in special, shock-absorbing transport cases. If these are not available we recommend well-upholstered packaging such as the coated carton in which the device was delivered.

We strongly advise not to use simple flight-cases without rack-in-rack mounting.

- **Environments**

This device can be used in E1, E2, E3, E4, or E5 environments (as listed below) according to the harmonized European standards EN55103-1 and EN55103-2 "Electromagnetic compatibility – Product family standard for audio, video and audio-visual and entertainment lighting control apparatus for professional use"

E1-Residential

E2-Commercial and light industrial

E3-Urban outdoors

E4-Controlled EMC environment e.g. broadcast and TV-studio

E5-Heavy industry

The product is intended for the use in moderate climate.

- **Ventilation**

Do not block or cover any ventilation slits. Install the device in accordance to the operating manual. Leave sufficient ventilation space around the units (at least approx. 200mm \equiv 7,87" free space behind the rear-panel) and care for free air movement near the ventilation-slits on both sides of the device. Keep the rear of the rack open during operation. Do not set up the device close to equipment producing a lot of heat, for example power-amplifiers. Leave enough space (minimum $\frac{1}{2}$ RU) to any heat emitting device. A DD6NE may be placed on top or beneath other Optocore products, except DD32, without additional space.

- **Water and Moisture etc.**

To prevent fire or shock hazard do not expose device to the effects of direct sunlight, dust, water, or rain during operation or storage.

- **Cleaning**

Only use a dry linen cloth to clean the device. In case of strong soiling moisten the cloth using a little water and a small amount of household detergent. Never use cleansing agents containing solvents to clean the device.

- **Operating and Storage Temperature**

Operating temperature: 0°C ...50°C \equiv 34°F ... 122°F; ensure proper ventilation

Storage temperature: -20°C ...60°C \equiv -4°F ... 140°F

- **Power Supply**

The device can only be removed from the power supply by pulling the plug. This must be freely accessible at all times. The switched-mode power supplies operate with high voltage. Coming into contact with them can lead to considerable electric shocks, which may result in death.

Never disconnect the main plug by pulling the cable, always pull the plug itself.

Power-supply cords should be routed in such a way that they are not likely to be walked on, crushed, pinched, or damaged in any other way. Pay special attention to the plugs and the sockets of the device.

Replace a damaged power cable immediately.

The device must be grounded; any disconnection of the grounding is not permitted. Always ensure the correct grounding of the device via the main plug. Never cover the grounding terminal of the plug by means of isolation material!

- **Fuse**

The main fuse cannot prevent an unexpected malfunction of electrical components; it is rather there to protect the user and its environment from damage. Therefore never try to replace the main fuse by any other than the specified D1.0A type (1.0A, slow behavior). Never try to repair or bypass a blown main fuse.

- **Lightning**

For additional protection of this device during lightning storms, or when it is left unattended and unused for a long period of time, unplug the power line. This will prevent damage to the device due to lightning and power line surges. Disconnection from the mains power supply can only be achieved by removing the plug from the mains socket.

- **Eye Safety**

This product is a Laser Class 1 product. It complies with IEC 60825-1, FDA 21 CFR 1040.10, and 1040.11.

- **Interference of external objects and/or liquids with the device**

Never push objects of any kind into the device through openings in the casing. They may come in touch with dangerous voltage points or short out parts that could result in a fire or electric shocks. Never spill liquid of any kind on the device.

- **Cables and Accessories**

Only use attachments specified by the manufacturer.

Only use high quality cable material to connect the device. For the optical data connection exclusively use the specified optical waveguide cables. If not in use, ensure that the optical connectors of both, device and waveguide are closed with the provided lids.

Do not place this device on an unstable table, tripod, cart, etc. The device may fall, which can cause injury and serious damage to the device. Any mounting of the device should follow the manufactures instructions, and should use mounting accessory recommended by the manufacturer.

- **Servicing**

Do not attempt to service this device yourself.

This device contains no user serviceable parts: only refer to authorized, qualified service personnel for any servicing.

The opening of the device is not required for operation as there are no user serviceable components located inside the device. The operation of an opened device is not permitted. It can lead to damage of components due to the absence of required ventilation. The device may not be serviced, altered or modified without authorization of Optocore or an Optocore authorized distributor / dealer. Only qualified service personnel may carry out repair and maintenance work. The warranty will be voided if unauthorized manipulation occurred.

CE-Conformity

This document confirms that the product DD6NE bearing the CE (Communauté Européenne) label meets all requirements in the EMC directive 2004/108/EG laid down by the Member States Council for adjustment of legal requirements. Furthermore the product complies with the rules and regulations of the low-voltage directive 2006/95/EG. This product bearing the CE label complies with the following standards, ratified by CENELEC (Comité Européen de Normalisation Electrotechnique):

Electromagnetic compatibility – Product family standard for audio, video, audio-visual and entertainment lighting control apparatus for professional use

EN 55103-1, Emission

EN 55103-2, Immunity

The authorised declaration and compatibility certification lies with the manufacturer and can be viewed on request. Responsible as manufacturer is:

OPTOCORE GmbH, Lohenstr. 8, 82166 Munich-Gräfelfing, Germany

Represented by Marc Brunke, Managing Director

N.B. The awarding of the CE label confirms the compliance with legal directives issued for the manufacture and marketing of electronic and electrical devices. As such the CE label is not a "seal of quality" but rather proof that the device bearing the CE label is conform with the electromagnetic compatibility standards laid down in the above named testing regulations.

Munich, 30.11.2007



Marc Brunke

Eye Safety

This product is a Laser Class 1 product. It complies with IEC 60825-1 and FDA 21 CFR 1040.10 and 1040.11.

DD6NE Fast Ethernet Distribution Switch Module

Table of Contents

Important Safety Instructions.....	2
Purchaser Information.....	3
CE-Conformity.....	5
Eye Safety.....	5
Device Description	7
Front Panel.....	8
Rear Panel	9
Device Details	10
Fiber Optic Connection	10
Ethernet Ports	10
RS485 Auxiliary Ports	10
Word Clock	10
Power Supply.....	10
Transmission Delay	10
Control.....	11
Channel Allocation	11
Connecters and Cables.....	12
USB-Connection	12
Word Clock-Connection	12
Mains-Connection.....	12
Starting Up	13
Software Installation.....	13
Optocore Network Setup.....	13
Hardware Connection	14
Network Examples	15
Connection Tables	16
Technical Specifications.....	17
Dimensions and Weight	18
Warranty and Liability.....	19
Shipping Contents.....	19
Company Information.....	20

Device Description

Congratulations on your purchase of a DD6NE Optical Digital Network Device with Fast Ethernet and data interfaces. The DD6NE will quickly convince you with its advantages and will facilitate your day-to-day work.

The DIGITAL I/O UNIT DD6NE is a digital interface device of the OPTOCORE® OPTICAL DIGITAL NETWORK SYSTEM. The unit provides six Fast Ethernet Ports for the transport of Ethernet compatible data via the fiber optical connection. In combination with other Optocore devices such as the YG2-card or other DD6NE a virtual switch is established. All Ethernet ports in a network behave like one 100 Mbps Fast Ethernet switch, no matter how far the devices are apart. Depending on the fiber optic transceivers distances from 700 m up to 70 km can be covered. The Ethernet ports of the DD6NE are equipped with standard RJ45 interfaces. The ports can be used for 10 Mbit or 100 Mbit Ethernet. Standard CAT5 cables connect external devices such as computers.

The importance of Ethernet for the transport of control data is steadily increasing in the event industry. All sorts of technical equipment incorporate an Ethernet interface to use the common, multifunctional Ethernet protocol for the transport of control data. This simplifies the configuration, operation and supervision of devices such as DSP-processors, loudspeaker management systems, etc. The DD6NE enables the transmission of Ethernet data via the fiber optical connection alongside with audio, video and other control data. No additional cables are necessary there are no limitations in cable length such as 100 m in standard 100Base-T connections. No repeaters complicate the installation of a network.

Additionally the DD6NE provides both word clock input and output. Four RS485 ports allow the transport of a wide range of standards such as RS422, DMX, MIDI, and CAN-Bus. The dual power supply unit, with automatic switchover, permits a redundant power supply and safeguards against malfunctions of the unit if one power supply fails to run.

Redundant fiber connections can be established using the two provided optical LINK-interfaces. The dual redundant ring structure provides maximum safety in a comprehensible network with an outstanding low latency. It facilitates the use of the advantages of fiber optical transmission and Ethernet in all sorts of temporary and permanent applications, especially when long distance connections are required.

The dual, 1Gbps full bandwidth optical interfaces are equipped with SC-connectors, commonly used and absolutely reliable in permanent installations. For rough applications such as touring and live productions the 1U OptoCon panel, with rugged and secure fiber optic connectors can be added to the rack.

Due to SMD production the DD6NE fulfills the demand of highest digital standards occupying only one rack unit of a 19" rack. The FPGA (field programmable gate array) based concept of the internal logic circuitry permits updating of the hardware via the units remote ports, ensuring a continual state-of-the-art device.

OPTOCORE CONTROL software is used to change the configuration or define own settings. It provides easy access to all configuration and control tools, storage and recall of configurations on the computer, off- and online mode. Additionally, the excellent word clock capability of the system is available at all nodes on a ring.

Front Panel

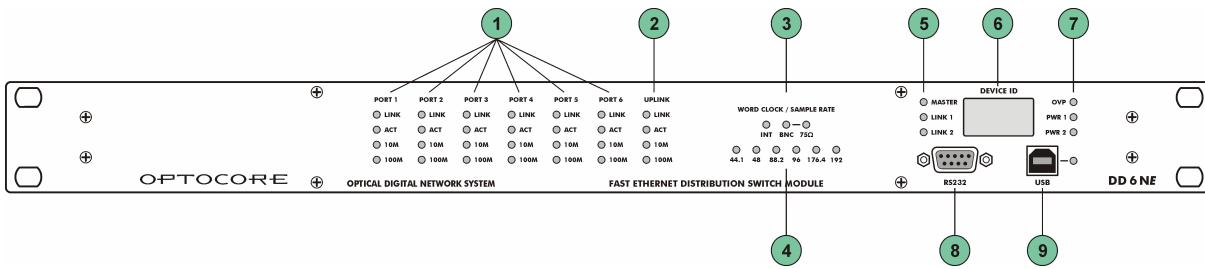

- 1 Port LED:** Indicates the status of the Ethernet ports:
 LINK: Ethernet data signal is present
 ACT: Data transmission is active
 10 M: 10 Mbps Ethernet is connected
 100 M: 100 Mbps Fast Ethernet is connected
- 2 UPLINK LED:** Indicates the status of the Ethernet data transfer via fiber optical connection:
 LINK: Ethernet data transmission via fiber is activated
 ACT: Data transmission is active
 10 M: 10 Mbps Ethernet is connected
 100 M: 100 Mbps Fast Ethernet is connected
- 3 Word Clock LED:** Indicates the selected word clock source:
 INT: Internal word clock
 BNC: External via BNC Input
 BNC 75 Ω: External via terminated BNC Input (75 Ω)
- 4 Sample Rate LED:** Indicates the selected sample rate
 44,1 / 48 / 88,2 / 96 / 176,4 / 192 kHz
- 5 Master LED:** Indicates the master unit
Link 1 LED: Communication is established via LINK 1 (rear panel)
Link 2 LED: Communication is established via LINK 2 (rear panel)
- 6 Device ID Display:** Indicates the network identification number (ID) of the device
- 7 OVP LED:** Indicates over-voltage protection (> 300 V_{AC})
PWR 1 LED: Power supply 1 is working correctly
PWR 2 LED: Power supply 2 is working correctly
- 8 RS232 plug:** D-Sub-9 RS232 connection for remote control and update via PC
- 9 USB plug and LED:** USB connection for remote control via PC
 LED ON indicates USB is connected;
 LED blinking indicates data traffic

Rear Panel

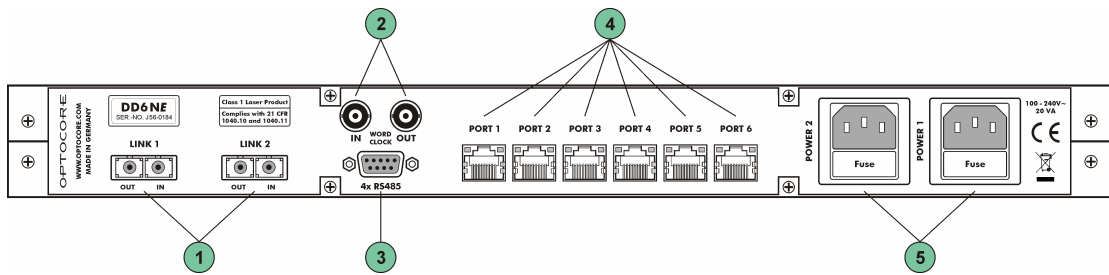

- 1**

LINK 1: Full-duplex, full bandwidth SC-type optical interface for data transmission
LINK 2: Full-duplex, full bandwidth SC-type optical interface for data transmission
- 2**

Word Clock IN: BNC Word clock input allows synchronization of Optocore devices to an external word clock source
Word Clock OUT: BNC Word clock output for synchronization of external devices
- 3**

4 x RS485 plug: D-Sub-9 RS485 AUXILIARY PORT for control data transmission
- 4**

PORT 1 ... 6: 6 x RJ45 jacks for Ethernet transmission
- 5**

POWER 1: Mains input for power supply 1 (100 ... 240 V)
POWER 2: Mains input for power supply 2 (100 ... 240 V)

Device Details

Fiber Optic Connection

The OPTOCORE® OPTICAL DIGITAL NETWORK SYSTEM uses a digital Time Division Multiplex technology (TDM) with a fiber channel based 8B10B-NRZI-coding. Static time slots guarantee the synchronous transmission of all channels at any time with no demand for dynamic bandwidth. All signals attached to the audio, video, word clock and auxiliary ports of the device are transmitted simultaneously on one fiber. The second fiber of one LINK-Interface is used to receive data. The second LINK-Interface has the same features as the first; therefore one of the LINK-Interfaces can always be used for redundancy.

Ethernet Ports

The six Ethernet ports of the DD6NE enable the connection of all sorts of devices with Ethernet interfaces. 10 Mbit and 100 Mbit Ethernet are supported.

All Ethernet ports in an Optocore network behave like one 100 Mbps Ethernet Layer 2 switch. The transport of Ethernet via the Optocore network and the local Ethernet ports are activated with OPTOCORE CONTROL, and the virtual switch is established without any further configuration.

The transfer rate on the fiber for the transport of Ethernet is 100 Mbps. It does not change with the number of active Ethernet ports or devices in the network.

RS485 Auxiliary Ports

The auxiliary ports provide four RS485 interfaces to establish a maximum of four half-duplex or two full-duplex connections between the devices. A wide range of bi-directional and unidirectional standards can be connected, such as RS485, CAN-Bus (bi-directional), or RS422, DMX, MIDI (unidirectional). The interfaces will sense automatically whether they send or receive control data. OPTOCORE CONTROL software is used for setting the destination of each interface.

Word Clock

The word clock input can be used to connect an external word clock source. An alternative clock source is the internal word clock. The synchronous data transmission with no buffers demands an absolute stable clock throughout the 1 Gbps network. Based on this clock the word clock available at the outputs is of superior quality with extremely low jitter.

The word clock outputs are used for the synchronization of external devices with digital I/Os such as preamps, controllers and consoles. All connected devices with digital I/Os have to get the word clock from the Optocore device with which they exchange digital audio data. The Optocore network is used to distribute the word clock.

Power Supply

The device is equipped with two power inlets and two independent power supply units. If one power supply fails, due to malfunction of the feeding power line or the power supply unit itself, the device will automatically switch over to the other power supply unit. In order to make the power supply redundant, both power inputs must be connected to the mains supply, if possible to different phases, power supply systems, or even better, one of them to an uninterrupted power supply (UPS).

The power supply units operate with mains voltage of 100 ... 240 V and frequency of 50 ... 60 Hz. Thus the device can be used throughout the world without any adjustments or transformers.

The power supply units are 400 V_{AC} tolerant and protected against high current. The OVP (Over Voltage Protection) LED on the front will indicate over voltage at > 300 V, simultaneously suppressing the normal function of the device. When the OVP LED is lit, immediately disconnect the device from the power line to prevent any damage to the device. Both power inputs have a fuse, replaceable without opening the device.

Never bypass the fuse and only use the specified type.

Be aware that the switched-mode power supplies operate with high voltages! Coming into contact with them can lead to considerable electric shocks that may result in death! To prevent electric shocks do not remove any covers!

Transmission Delay

The Optocore system delay is fixed to 41,6 µs. The transport delay per Optocore unit (<200 ns) in the network is insignificant. The transmission delay is constant from any point to any point. Delays caused by the fiber cables with 'normal' cable lengths of <700 m can also be considered as marginal.

Control

All system and device parameters are set with the OPTOCORE CONTROL software on a PC, connected to the device via RS232 or USB port. Third party protocols for device controlling can be used, if previously adapted by Optocore.

Channel Allocation

The standard channel allocation is as follows:

Audio	256 Channels @48 KHz
RS485 Data	32 Channels
Video	1 CVBS Video Channels *
Ethernet	100 MBit Fast Ethernet *

* If the network is used for the transport of Ethernet compatible data the capacity is reduced to one CVBS video channel plus 100 Mbps Fast Ethernet.

Connecters and Cables

Optical Connection

The dual optical LINK-Interfaces are equipped with duplex SC connectors. Standard SC cables with two fibers can be used. Worst case reach is 700 m with multimode transceivers and a 50 μm fiber, whilst with monomode transceivers and a 9 μm fiber, up to 70 km are possible. For rugged applications e.g. touring and other temporary installations, HMA Expanded Beam Connectors mounted on 1 RU panel are available, along with matching, inter-connection cables transported on cable drums. (Please refer to Product_Brochure_2007.pdf available at www.optocore.com).

Ethernet Ports

The Ethernet ports are equipped with eight-pin jacks, commonly labeled as RJ45. Standard straight through CAT5 cables can be used to connect external devices.

Auxiliary Ports

According to the RS422/RS485 hardware standard, each channel requires a twisted pair. A common braided shield should enclose the pairs.

Standard computer data cables are absolutely sufficient.

RS232-Connection

Shielded, standard 1-modem cable is sufficient for the RS232 port.

Connector Hood Quality

Applied locking screws for the D-Sub-types must be acc. to 4-40 UNC. Care should be taken in selecting the right types of connector hoods in order to fulfill the requirements of EMI-radiation directives. Full metal connector hoods should be used, approved acc. to VDE 0871, FCC 20780 and EMC directive 2004/108/EG, providing an reduction > 40 dB on 30 MHz up to 1 GHz. The shielding harness of the cable should have complete contact to the connector hood.

USB-Connection

For the USB-port use a standard PC/device cable.

Word Clock-Connection

Word Clock connection: 75 Ω -BNC

Mains-Connection

Standard power cords with IEC C13 socket can be used.

Starting Up

Software Installation

Installation requirement for the software is a functioning computer system with Microsoft® Windows 95/98/2000/NT/XP/Vista® operating system. The computer should be equipped with an USB interface for configuration and remote controlling, and a RS232 interface (or an appropriate USB / RS232 converter) for firmware upgrade. COM 1...4 can be used with a transfer rate of 57 600 Baud. Monitor resolutions of 800 x 600 or 1024 x 768 with 16 Bit color rendering are recommended to view the program. The installation requires approx. 2.5MB of hard-disk space and is carried out in the usual Windows-program manner.

Please note that the serial interfaces on computers are usually not capable of “Hot Plugging”. Switch off the computer to avoid damage before establishing the serial connection between the Optocore device and the computer.

The set-up software *OCSETUPXXX.EXE* is available on CD or can be downloaded from www.optocore.com. OPTOCORE CONTROL for configuration and remote controlling, and OPTOCORE UPGRADE for firmware upgrading are installed on a PC or Laptop by double-clicking on the *OCSETUPXXX.EXE*. The set-up executable program is self-extracting and provides the OPTOCORE CONTROL SETUP WIZARD. It will establish the necessary directories, a desktop icon for the OPTOCORE CONTROL and firmware upgrade software.

The uninstall procedure of OPTOCORE CONTROL can be carried out with the *ADD OR REMOVE PROGRAMS* tool of Windows, which is usually found under *START / CONTROL PANEL*.

For details about features and handling of OPTOCORE CONTROL please refer to the *HELP* menu of the software. We strongly recommend getting familiar with the OPTOCORE CONTROL software.

Optocore Network Setup

Before connecting a DD6NE to any other device and before establishing the optical LINK connection make sure that all devices have a basic set-up in order to be able to operate correctly. For operation safety reasons, some settings (e.g. “ID”) may only be made when locally connected to a device.

All devices in the network must operate with the same firmware version. The firmware version can be revised under *SET / LOCAL SETTINGS*. The update of the firmware is done with the OPTOCORE UPGRADE software under *START / PROGRAM / OPTOCORE / UPGRADE*. Please refer to the *HELP* Menu for further information. For Firmware updates the PC has to be connected via the RS232 Port on the front of the device.

The transport of Ethernet via the fiber optical connection has to be activated at all devices in the network, no matter if they are equipped with an Ethernet port or not. This is done with OPTOCORE CONTROL in the *LOCAL SETTINGS* dialog.

The best approach to check the settings is to connect locally to every single device of the Optocore network with a PC using either RS232 or USB connection, run the OPTOCORE CONTROL software and enter menu *SET / LOCAL SETTINGS*. This dialog enables the definition of the ID, ports, etc.

- **General:** Set each device in the optical network to a unique ID. Device IDs must be unique in the entire Optocore network. Usually the device with the lowest ID and a word clock input will determine the clock of the network. It is advisable to assign ID 1 to the device with word clock input connected to the most important console, e.g. the FOH console.

Master Priority allows to force a device to act as word clock master of the network. The device with the lowest ID, a checked Master Priority and a word clock input will act as master.

Devices with a word clock input such as DD32E, PTP32E, DD4ME, DD6NE, YG2, always have priority before devices without word clock input such as DD32, LX4AP, LX4B. So even if the Master Priority is checked in the local settings of a device without word clock input, the device with the lowest ID and word clock input act as word clock master of the network.

- **Clock Setup:** All devices in the network must work with the same sample rate. *CLOCK SOURCE* allows the selection of Auto (BNC priority), *INT*(internal) or *BNC* (external) word clock signal.
- **Ethernet Setup:** marking the two boxes OPTOCORE ETHERNET TRANSPORT and ENABLE LOCAL ETHERNET does the activation of the Ethernet ports and the Transport via fiber.

The *ETHERNET SETUP* and *RS485 SETUP* can be changed with *LOCAL SETTINGS* and via the network with *NETWORK LOCAL SETTINGS* as well.

- **RS485 Ports:** The *RS485 SETUP* is used to define which signal is given out at the specific port of the device. It is not necessary to define any inputs. If the BI-C cable is connected, the RS485 ports 3 and 4 will send or receive data.

To illustrate the setting of the ports in OPTOCORE CONTROL a configuration with a DD6NE at FOH and a DD6NE on stage will be used as an example. The DD6NE at FOH with ID 5 will transmit control data to an external device at Port 3 and receive data at Port 4. The DD6NE with ID 6 on stage will transmit control data to an external device at Port 3 and receive data at Port 4 as well. Accordingly the data received at ID 6 / Port 4 has to be transmitted by ID 5 / Port 3 to the data port of the external devices at FOH. This is the return path from the stage devices to the FOH device. In order to enable this connection the *RS485 SETUP* of the FOH device with ID 5 is:

Local settings for	Device (where the data is received)	Port (where the data is received)
ID5 / Port 3	ID 6	Port 4

None of the other RS485 Ports have to be adjusted and can be disabled. The definition of the ports as *DISABLED* only declares that they are not used as outputs. Data received at the disabled ports will be transported to any destination by the fiber optic connection.

To establish the command path from the FOH device to the stage device the *RS485 SETUP* of ID 6 is:

Local settings for	Device (where the data is received)	Port (where the data is received)
ID6 / Port 3	ID 5	Port 4

Click on *WRITE* first, confirm with *OK*, and then click *CLOSE* to exit the dialog.

You may now connect the optical LINK cables between all Optocore devices.

Check your setup by connecting to any device using either RS232 or USB connection, running the OPTOCORE CONTROL software and starting *ONLINE MODE* in the *SET* menu. The entire network at its current state is now displayed in the control software. Check the *LOG WINDOW* for any error messages. All Optocore devices memorize the current setup, even if they are switched off or disconnected from the power supply.

Never switch on power amplifiers before the complete system is stable and the OPTOCORE CONTROL level meters indicates a normal level.

Hardware Connection

An exemplary network with four devices is shown in Fig. 1. It is established by creating a (non-redundant) loop simply through "daisy-chaining" the units and monitoring the three status LEDs of each device, as revealed through the signal flow in diagram. There is no need to worry about the sequence of neither IDs nor which of the two LINKS of a device is used for connection. The only condition is that an optical input must be connected to an optical output. During the self-configuring of the network the system word clock master will be automatically determined as indicated down under *Optocore Network Setup – General* . If the DD6NEs are previously configured, the network is ready to work. With a PC connected to any unit in the loop and by running the OPTOCORE CONTROL software, the network may be analyzed, supervised, parameters may be changed and the matrix can be accessed for signal-routing.

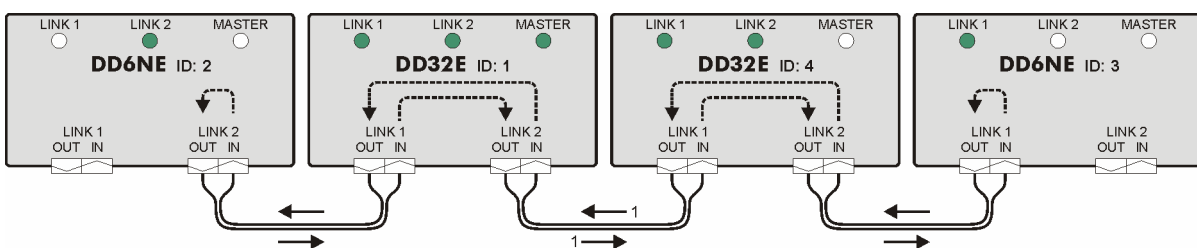

Fig. 1: Two DD6NE and two DD32E in a non-redundant network

A second redundant reverse loop can be additionally created with only one more connection from the last unit of the chain back to the first, as demonstrated by the signal flow diagram in Fig. 2

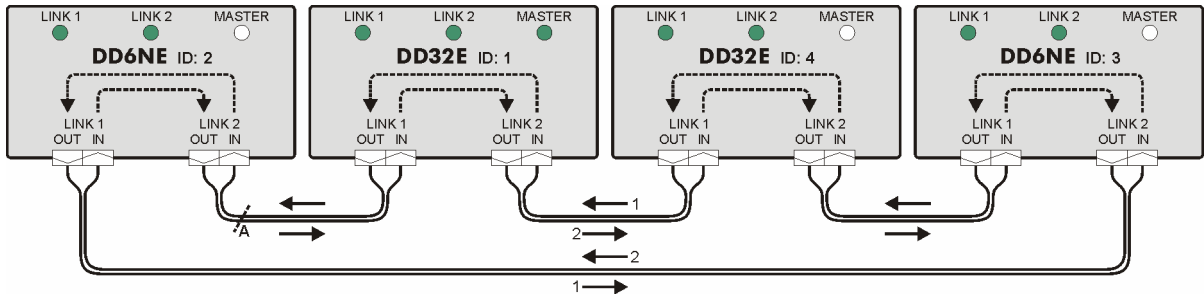

Fig. 2: Two DD6NE and two DD32E in a redundant network

In case an interruption occurs at position a or b as illustrated above, this will only result in a loss of redundancy. In case of an interruption at both positions, the network will be divided into two independent sub-networks. These will automatically reconfigure themselves. One sub-network includes the units ID 1 and ID 4 with ID 1 keeping its job as a master for the sub-network. The second includes the units ID 2 and ID 3 with ID 2 now determined as the "new" master of this sub-network. Therefore a maximum possible data security is preserved through the intelligence of the self-configuration.

In the unlikely case of a DD6NE failure, only redundancy is lost. The ring can be reestablished simply by connecting the in and out fiber with the help of an adapter and a new device can be integrated at any time.

Network Examples

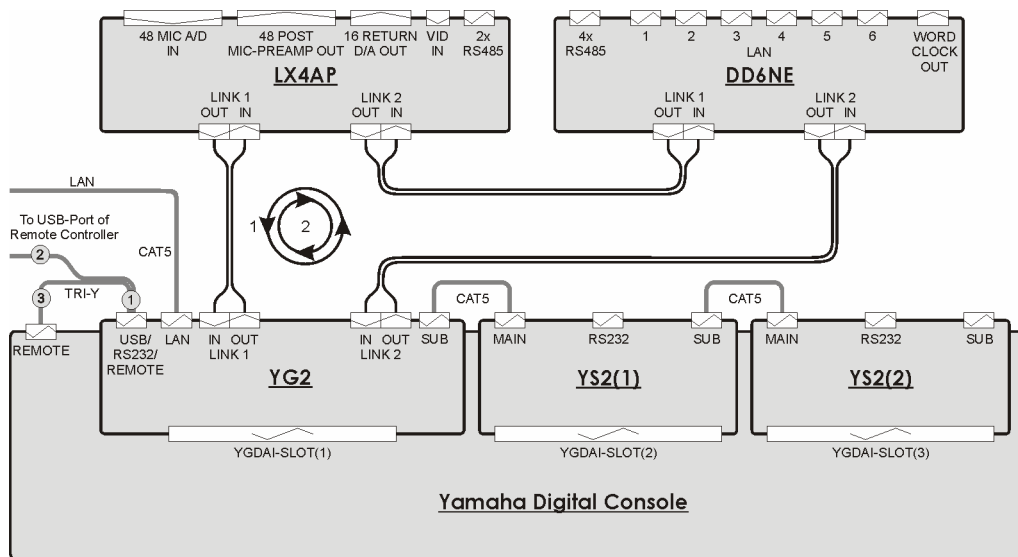
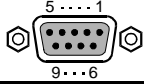
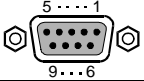

Fig. 3: Redundant network with Ethernet interfaces at the YG2 card and the DD6NE

Connection Tables

Pin-out		Auxiliary Ports 4 x RS485						
	Channel	RS485				GND	Please assure correct polarity "+" and "-" at both (!) sides / devices when connecting external equipment to the RS485 ports.	
		1	2	3	4			
Pin	+	1	2	3	4	5		
	-	6	7	8	9			
D-Sub-9- female						Locking system acc. to 4-40 UNC		

Pin-out		RS232-Port							
	Channel	RS232		Internally Bridged	Power		Use 1-modem cable, male – female, to connect to PC		
		RXD	TXD		+5VS	GND			
Pin	3		2		1, 4, 6			7, 8	
	9		5						
D-Sub-9- female						Locking system acc. to 4-40 UNC			

Pin-out		USB-Port				
	Channel	USB			GND	USB device-connector
		VBUS	D -	D +		
Pin	1		2	3	4	

Pin-out		RJ45-Port						
	Channel	RJ45					Use standard Ethernet cable	
		TX+	TX-	RX+	RX-	Unused		
Pin	1		2	3	6	4, 5, 7, 8		

Technical Specifications

Ethernet Ports		Convention IEEE 802.3i, 802.3u, TIA 568A
Data ports	Compatible to 10 MBit and 100 MBit-Ethernet	6 RJ45
Data rate	Fast Ethernet	100 Mbps
Auxiliary Ports		Convention EIA / TIA-485
Data channels	Digital control data	4
Data rate		Up to 10 Mbps
Impedance	Termination	330 Ω
	Source	$\leq 10 \Omega$
Drive level	Output	$\geq 2 V_{DD}$
Zero level	Referring to GND	+ 2.5 V
Sense level	Input	$\geq 400 mV_{pp}$
Max. voltage at bus terminals	Referring to GND, including common mode voltage	- 7V ... + 12 V
	Differential voltage	$\leq 6 V_{DD}$
RS232 Port		Convention EIA / TIA-232
Data channels	Digital control data	R x D, T x D
Data rate		57 600 Baud
USB Port		Remote control input
		No transmission purposes
Word clock		Hardware standard 75 Ω / BNC
Data rate	Depending on used sample rate	Up to 192 kHz
Impedance	Output	75 Ω
	Input	1k / 75 Ω software switch
Drive level	Output	$\geq 2 V_{pp}$
Zero level	Referring to GND	+ 2.5 V
Sense level	Input (DD32E only)	$\geq 400 mV_{pp}$ AC-coupled
Link		Input, Output, Dual – Full bandwidth
Connection		Duplex SC
Protocol		Optocore
Transmission		Full duplex
Data rate		2 x 1 Gbps
Optical wave guide cable lengths	Multimode fiber 50 μm	$\leq 700 m$
	Multimode fiber 62.5 μm	$\leq 350 m$ (not recommended)
	Monomode fiber 9 μm	$\leq 70 km$ (on request)
Power supply		2 independent power supplies with function check and automatic switch-over
Type	Switch-mode, universal input	
Mains voltage	100 ... 240 V, 400 V _{AC} tolerant	
Frequency	50 ... 60 Hz	
Power consumption	16 VA-idle, 20 VA-peak	
Fuse	D1.0 A, slow behavior, glass 5 mm x 20 mm, acc. to UL 48-14	
Inrush current limit	$\leq 7 A$	
Protection circuit	400 V _{AC} tolerance, over-voltage, over-current and over-temperature monitor	
Security classification	Class 1: basic insulation, connected to the protective grounding conductor	
Security regulations	Harmonized European standard EN60065	
Mains connector	Including EMI-filter, a fuse and spare-fuse, acc. to IEC-950	
Cooling	Via surface and ventilation-slits on both sides	

Dimensions and Weight

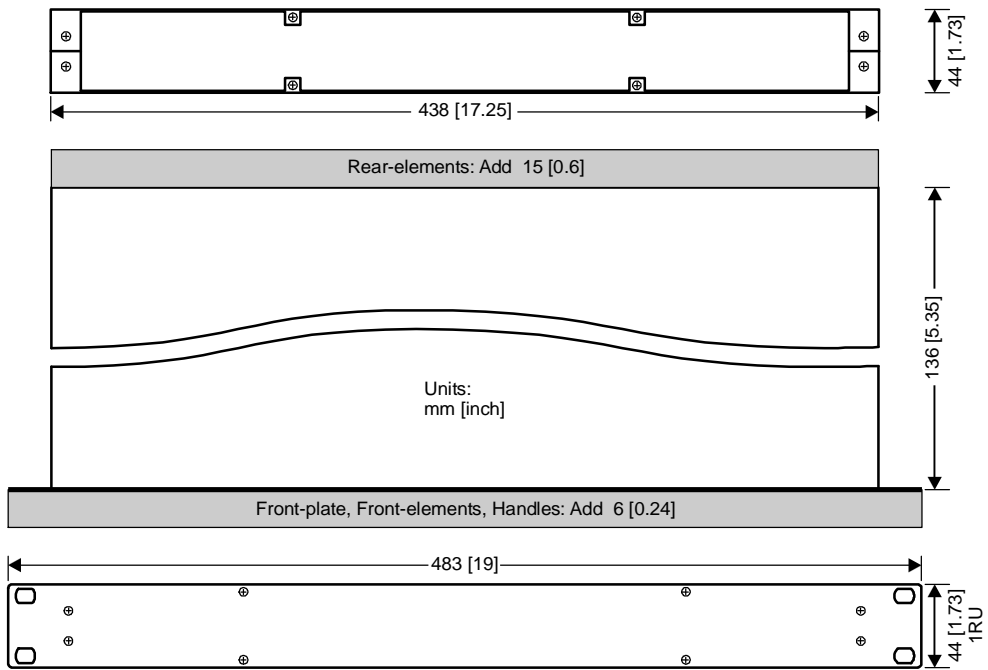

Weight

2.2 kg \approx 4.8 lbs

Modifications that serve the purpose of technical improvement of the device may be carried out without prior notification.

Warranty and Liability

Summary of Warranty

Optocore DD6NE is warranted against defects in material and workmanship for 24 months.

This warranty covers the original purchaser only and is not transferable. Valid evidence for warranty is the official Optocore invoice issued by the distributor / dealer.

Optocore will, at its discretion, repair or replace a defective product, providing that the defect has appeared under normal operating conditions.

This warranty does not cover damage from acts of God, accident, abuse, neglect, contamination, unauthorized modification or misuse, operation outside of the environmental specifications for the product, improper site preparation or maintenance, or abnormal conditions of handling. This would include over-voltage failures, and conditions outside of the products specified ratings, problems with buyer-supplied software or interfacing, or normal wear and tear of mechanical components. Optocore or its distributor / dealer will acknowledge the evaluation of warranty after inspection.

Devices on which the Serial Number has been removed or defaced are not eligible for warranty service.

Failure to properly package and protection of the product during shipping may void this warranty.

How to Obtain Warranty Service

To return a defective product, please contact your distributor / dealer. Our web site: <http://www.optocore.com/> provides a complete list of Optocore distributors / dealers.

Always ensure the careful handling of the device. If possible transport or shipping should always occur in special, shock-absorbing transport cases. If these are not available we recommend well-upholstered packaging such as the coated carton in which the device was delivered.

We strongly advise not to use simple flight-cases without rack-in-rack mounting.

Declaration of Liability

Optocore accepts no liability for damage caused to other devices through operation of the DD6NE device.

Optocore is not liable for any damage caused by shipping accidents, misuse, abuse, operation with incorrect AC voltage, operation with faulty peripheral equipment, or improper or careless installation of the device.

Optocore accepts no claims for compensation whatsoever (e.g. cancellation of events).

Shipping Contents

The standard shipment of a DD6NE device contains the following:

- 1 DD6NE device
- 1 SC-SC patch cable (2m)
- 2 D1.0A (1.0A, slow behavior) replacement fuses per device
inserted next to the operational fuses in the power supply inlets.
- 1 operating manual

Any additionally purchased equipment such as optical wave-guide cables in required lengths, D-Sub cables and adapters, RS232 cables, and international electric cables have been supplied on your request and your purchase order and cannot be listed in the above.

Company Information

Mailing Address:

OPTOCORE GmbH
Lohenstr. 8
D-82166 Munich-Gräfelfing
Germany

Telephone:

+49 – (0)89 – 8999640

Facsimile:

+49 – (0)89 – 89996455

Internet:

www.optocore.com

Email:

inquiry@optocore.com